

## Manual - Campetto 4 Underfloor distributor system

### Imprint:

GIFAS-ELECTRIC GmbH  
CH-9424 Rheineck  
Switzerland  
[www.gifas.ch](http://www.gifas.ch)

Technical changes and errors reserved.

This manual is property of GIFAS-ELECTRIC GmbH and may not be reproduced, copied, translated, transmitted, duplicated or transferred to third parties in part or in whole without previous written authorization by GIFAS-ELECTRIC GmbH.

version: V1.02/0814  
English

---

1.	Basic information	3
1.1	Areas of applications	3
1.2	Product features	3
1.3	Scope of delivery	3
1.4	Product characteristics	3
1.5	Technical information	3
1.6	Documentation	4
1.6.1	Product identification/ CE label	4
1.6.2	Labelling concept for integrated text and references	4
1.7	Storage	4
1.8	Disposal	4
1.9	Service address	4
1.10	Operator's responsibilities	5
2.	Assembly and installation	6
2.1	Work to be done on site by customer	6
2.2	Principle drawing	7
2.3	Installation	8
3.	Maintenance	9
3.1	Inspection and maintenance schedule	9
3.2	Description of maintenance and inspection works	9
4.	Debugging	9
4.1	Measures for elimination of errors	9
5.	Declaration of conformity	10

## 1. Basic information

### 1.1 Areas of applications

Industrial buildings, hangars, sports facilities, pedestrian zones, town squares, as well as school buildings and anywhere where power distribution must be available quickly and regularly.

### 1.2 Product features

Basic features and benefits of Campetto 4:

- stainless steel box with drainage hole
- stainless steel lid with cable outlet for closed operation
- closed operation provides high security for operators, vehicles and pedestrians
- high-end solid rubber power distributor for tough conditions
- high-end solid rubber junction box for connection to main supply
- compressed air, video/audio, data or water available on request
- protection against vandalism thanks to lockable lid
- easy and quick opening and closing thanks to gas springs
- load capacity 3 tons (depending on model)
- almost maintenance free and therefore very low operating costs

Dimension, depth, lid strength and electrical installation equipment depend on customer's requests.

### 1.3 Scope of delivery

The Campetto casing including the electrical distribution and junction box are delivered ready-to-install. Cabling, filling with concrete, drainage e.g. has to be provided by customer.

### 1.4 Product characteristics

The basic characteristics of the Campetto 4 model are:

- Fits type KSV 7200-7700 (Ø 600mm) or max. type KSV 7800 (Ø 800mm)
- Reservoir cover for individual filling
- By means of a cable exit flap, the Campetto 4 can be closed during operation

Size, depth, cover thickness and equipping of the distributor box depend on the customer's specific requirements.

### 1.5 Technical information

- Model Campetto 4 is available in different dimensions/sizes (max. distributor type 7800)
- Suitable for electricity, water and compressed air
- GIFAS hard rubber distributor, which is mounted on the lid, can be equipped individually.
- The dimension of the junction box is depending on electrical needs and is installed in the casing.
- The lid is available in different classes of load capacity (standard B125, special executions up to class C250 possible)
- Standard execution in stainless steel V2A/1.4301 (on demand hot-dip galvanised)
- Easy, quick opening and closing, supported by gas springs; these gas springs reinforce your muscle craft, and are for a controlled opening and closing of the GIFAS underfloor distribution systems.
- The lid can be equipped optionally with a heating system (equipping by customer himself or by GIFAS).

1.6 Documentation

1.6.1 Product identification/ CE label



The CE label indicates that your device meets the safety requirements of EU Directive 2006/95/EEC.

1.6.2 Labelling concept for integrated text and references



**DANGER**

Dangerous situation that will certainly cause a serious injury or death, if not avoided.



**WARNING**

Dangerous situation that may cause a serious injury or death, if not avoided.

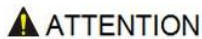

**ATTENTION**

Dangerous situation that may cause a moderate injury, if not avoided.



**INDICATION**

Designs information, which causes danger of property damages e.g., but not personal injuries.

1.7 Storage

Underfloor distributor shall be stored in a dry place, no other action is needed

1.8 Disposal



This product must not be thrown in the garbage.

In accordance with official local and national regulations, this product is to be recycled appropriately.

European WEEE Directive 2002/96/EC; Waste Electrical and Electronic Equipment

1.9 Service address

**GIFAS-ELECTRIC GmbH**  
Dietrichstrasse 2  
Postfach 275  
CH-9424 Rheineck

Phone: +41 7 18 86 44 44  
Fax: +41 7 18 86 44 49

[www.gifas.ch](http://www.gifas.ch)  
[info@gifas.ch](mailto:info@gifas.ch)



### 1.10 Operator's responsibilities

 **WARNING**      **To ensure personal safety, the operating manual must be carefully followed. Incorrect installation or incorrect operation of the product can result in serious injury.**

**The Gifas inspection and maintenance schedule must be adhered to.**

1. The installer must provide the user with all the information relating to the operation of the system. Make sure that this document is always kept in a readable state along with the product.
2. Read this operating manual carefully during the planning phase, before installation and putting into operation.
3. This product is designed and manufactured exclusively for the use indicated in this document. Any other use not expressly indicated here could compromise the integrity of the product and / or be a source of danger. Changes must not be made to the underfloor power distributor system components.
4. The manufacturer declines any liability for damage caused by improper or inappropriate use of the product.
5. The product shall not be installed in a potentially explosive atmosphere. Flammable gas or fumes constitute a serious safety risk.
6. For countries that are not members of the European Community, the standards and regulations applicable in those countries must be followed in addition to national legal regulations in order to guarantee a certain level of safety.
7. The installation must be carried out in accordance with applicable regulations.
8. The manufacturer assumes no liability in the event of improper execution during assembly or for any deformation that may occur during operation.
9. Only original parts from GIFAS may be used for maintenance. The manufacturer declines all liability with regard to the safety and trouble-free operation of the underfloor distributor system if components that were not approved by the manufacturer are used in the installation.
10. Only qualified personnel may perform operations on the underfloor distributor system.
11. All procedures not expressly designated by the manufacturer in the operating manual are not permitted.
12. Neither children nor adults may be in the immediate vicinity of the underfloor distributor system when it is in operation.

Power supply:

13. Before any intervention on the system, the electrical power must be switched off.
14. The Underfloor distributor system main power supply must be protected in accordance with current regulations and manufacturer instructions.
15. It is necessary to verify that the earthing system is properly installed.

## 2. Assembly and installation

### 2.1 Work to be done on site by customer

The cover system is not sealed against surface water; this means that the customer must provide for the drainage of the underfloor distributor system. The customer must therefore ensure that an appropriate drainage line or drainage system is installed.

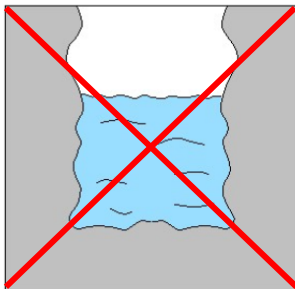

Without drainage/  
Drain pipe

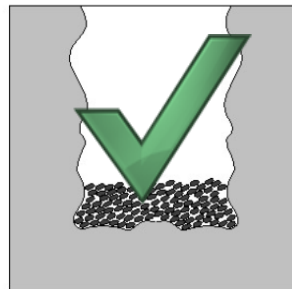

with drainage bed  
(e.g. loose subsurface)

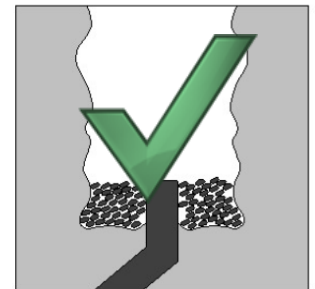

with drain pipe  
(e.g. solid subsurface)

40L in 30 min.

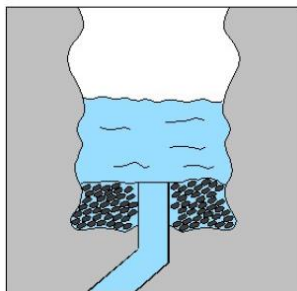

Check drainage capacity!

The excavation work as well as the professional and standards-compliant installation must be performed by the customer. It is important to ensure that the load capacity of the foundation and/or the cover layer corresponds to the load capacity of the underfloor distributor system in order to prevent subsidence. Delivery of concrete pipe has to be done on site by the customer.

#### **WARNING**

If the Underfloor distributor system is to be used immediately after the excavation work, the installation pit must absolutely be secured or locked so that it does not pose a safety risk!

Underfloor distributor systems that are operated in open mode must not pose a safety risk when in operation (risk of falling, manipulation).

The electrical connection may only be made by trained personnel and is the responsibility of the operator.

2.2 Principle drawing

**INDICATION**

The details necessary for proper installation can be found on the project-specific drawing from GIFAS. Custom models may vary from the following drawings.

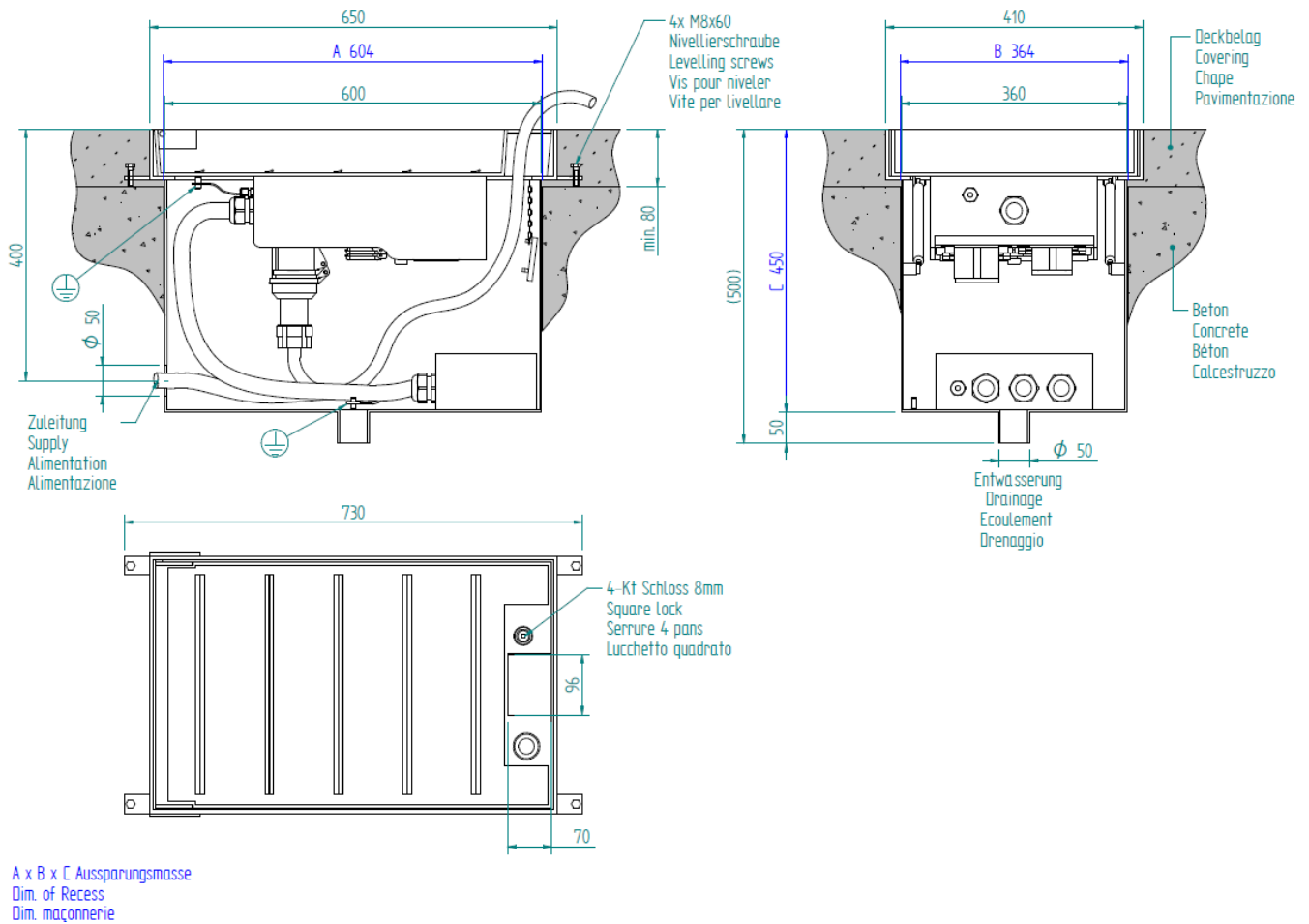

The cover opens automatically through the use of gas springs. They support muscular force and allow for the controlled opening and closing of the cover.

2.3 Installation

**INDICATION**

Tighten any bolted connections that have been loosened due to transport or installation.

Open the cover carefully! Do not overstretch the gas spring with a cover that has not been filled up!

Before filling, the lock, hinge, and joints must be covered in order to prevent contamination with the adhesive mortar.



Do not overfill the cover!

The surroundings must not sink!

Top filling tolerance +0/-1mm

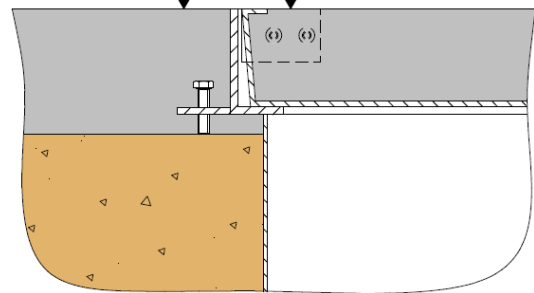

- Have authorized personnel connect the electrical supply to the junction box and monitor the Campetto in accordance with the following inspection schedule.



### 3. Maintenance

#### 3.1 Inspection and maintenance schedule

Work to be done	Period
Monitor for damage	at each use
Cleaning of hinge, lock, and cover surface	before closing each time
Monitor surroundings for sinking	annually
Test functioning of the gas spring(s)	annually
Test functioning of the hinge and lock	annually
Lubricate hinge and lock	annually
Check bolts	annually
Clean the drainage	as needed / when dirty
Monitor the electrical distribution	according to country-specific regulations

 **WARNING** Gas springs are wear parts and must be replaced immediately in case of pressure loss in order to ensure a safe and gradual closing of the cover.

#### 3.2 Description of maintenance and inspection works

Lock system, lid hinge bar and gas springs need to be checked, cleaned and where necessary to be greased in appropriated intervals.

The lid surface needs to be cleaned from dirt in appropriate intervals, to ensure a safe and proper closing.

The underfloor distributor needs to be maintained and revised by professionally trained personnel, according to national regulations and standards.

### 4. Debugging

#### 4.1 Measures for elimination of errors

Bug/error	Possible cause(s)	Solution
Cover can hardly be opened	Gas spring failure	Replace gas spring
Cover can hardly be opened	Dirty hinge or gas spring	Clean the hinge or gas spring
Cover closes too fast	Gas spring failure	Replace gas spring
Cover will not close	Cover surface dirty	Clean the cover surface
Cover will not close	Lock failure	Clean / change the lock
Cover jiggles	Hinge failure	Change the hinge
Earth leakage circuit breaker is triggering	Electrical fault	Repair by professionally-trained personnel

## 5. Declaration of conformity

GIFAS-ELECTRIC GmbH  
CH-9424 Rheineck · Dietrichstrasse 2  
Postfach · Telefon +41 71 886 44 44



### KONFORMITÄT SERKLÄRUNG / DECLARATION OF CONFORMITY / DECLARATION DE CONFORMITE

Wir / We / Nous: GIFAS-ELECTRIC GmbH, CH-9424 Rheineck

erklären in alleiniger Verantwortung, dass das nachfolgend aufgeführte Produkt aufgrund seiner Bestückung und Bauart in der von uns in Verkehr gebrachten Ausführung den einschlägigen Sicherheits- und Gesundheitsanforderungen der EU-Richtlinie entspricht. Bei einer nicht mit uns abgestimmten Änderung des Produkts verliert diese Erklärung ihre Gültigkeit.

declare under our sole responsibility that the product about the equipment and construction as we put the execution into circulation of the appropriate security and health requested, correspond with the European guideline. Any change on the product without our agreement has the consequence, that the declaration will lose its validity.

déclarons sous notre seule responsabilité que le produit sous mentionné correspond aux exigences de sécurité et de santé des lignes d'application CE, en raison de son équipement et son genre de construction. Cette déclaration perd sa validité lors de modification du produit sans notre accord.

**Produkt:** Unterflurverteiler  
**Product:** Underfloor distributor systems  
**Produit:** Distribution électrique souterraine

**Typ/Type/Type:** Campetto 1-8, B125/C250

**EU-Richtlinien:** Niederspannungsrichtlinie 2006/95/EG  
**EC-Guidelines:** Low-Voltage Directive (LVD) 2006/95/EC  
**Directives de la CE:** Directive Basse Tension 2006/95/EC

**Angewandte Normen/  
Applied standard/  
Normes:** EN 124 – B125/C250  
SN 640366 – Gruppe 2/3  
EN 60439-1

CH-9424 Rheineck, den 16. Mai 2013

GIFAS-ELECTRIC GmbH



E. Hasler, Geschäftsführer  
E. Hasler, Managing Director  
E. Hasler, Président-directeur général

GIFAS-ELECTRIC GmbH · Dietrichstrasse 2 · CH-9424 Rheineck · Telefon +41 71 886 44 44 · Telefax +41 71 886 44 49 · info@gifas.ch